



Design  
Award  
Winner  
2000



reddot



**excellent!**  
**Design Center Stuttgart**

Front dimensions:  $\varnothing$  28 mm  
Panel cut-out:  $\varnothing$  22.3 mm  
Front bezel height: 12 mm  
Travel: 6 mm



Product configurator



RVVA

## Overview RVA series



- |    |                   |          |
|----|-------------------|----------|
| 01 | Pushbutton Heads  | page 274 |
| 02 | Selector Heads    | page 275 |
| 03 | Key Actuators     | page 276 |
| 04 | Pilot Light Heads | page 276 |

**Contact Blocks / Lampholders** page 408

## Housing Colour



**IP65** degree of protection

**6 mm** operating travel

 illuminating option

 labelling option

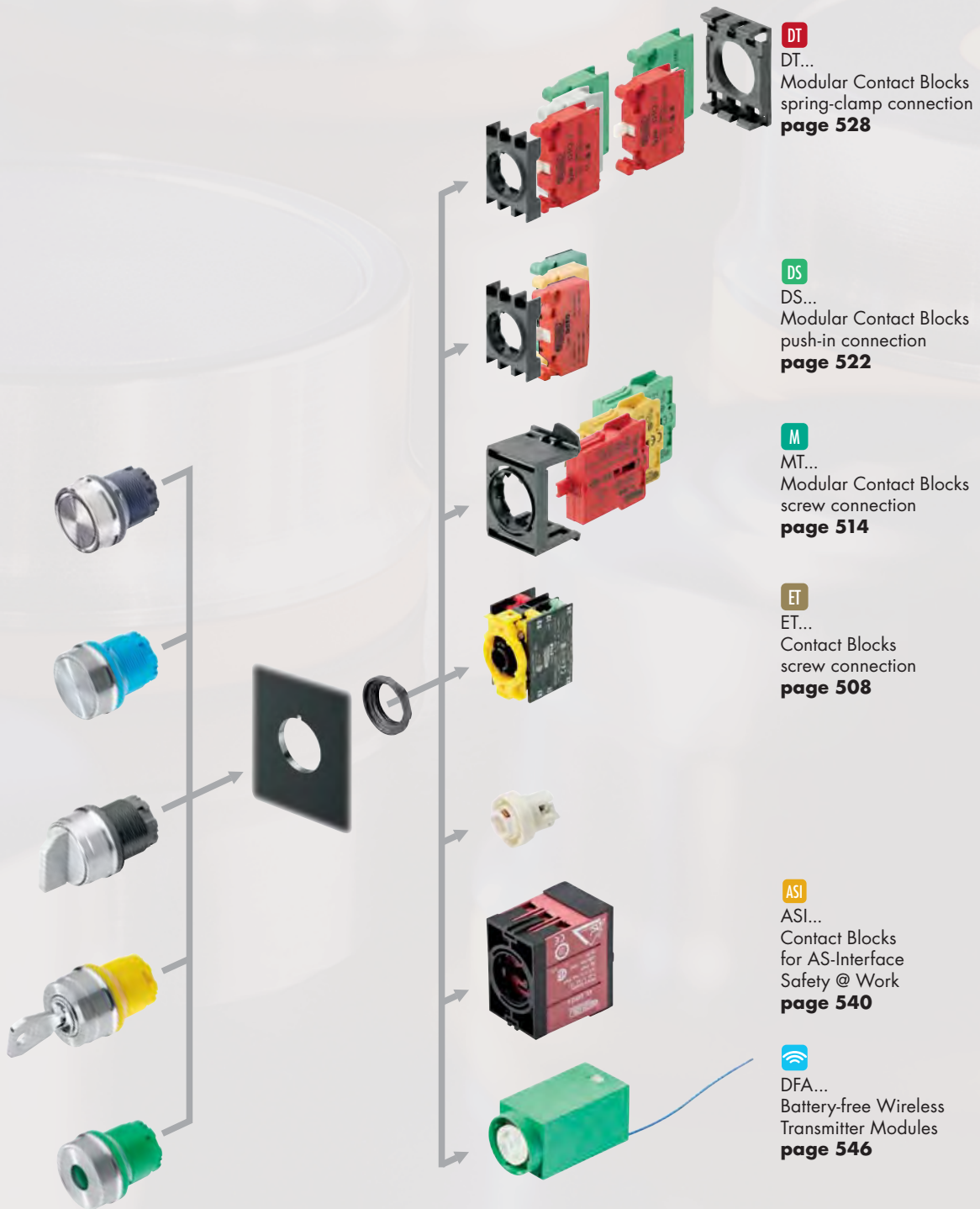

**DT**

DT...  
Modular Contact Blocks  
spring-clamp connection  
**page 528**

**DS**

DS...  
Modular Contact Blocks  
push-in connection  
**page 522**

**M**

MT...  
Modular Contact Blocks  
screw connection  
**page 514**

**ET**

ET...  
Contact Blocks  
screw connection  
**page 508**

**ASI**

ASI...  
Contact Blocks  
for AS-Interface  
Safety @ Work  
**page 540**

**WiFi**

DFA...  
Battery-free Wireless  
Transmitter Modules  
**page 546**

**When combining the DT... contact blocks with key, selector and toggle heads,  
please add ...\_497 to the actuator type reference!**

## Mounting Depth Dimensions

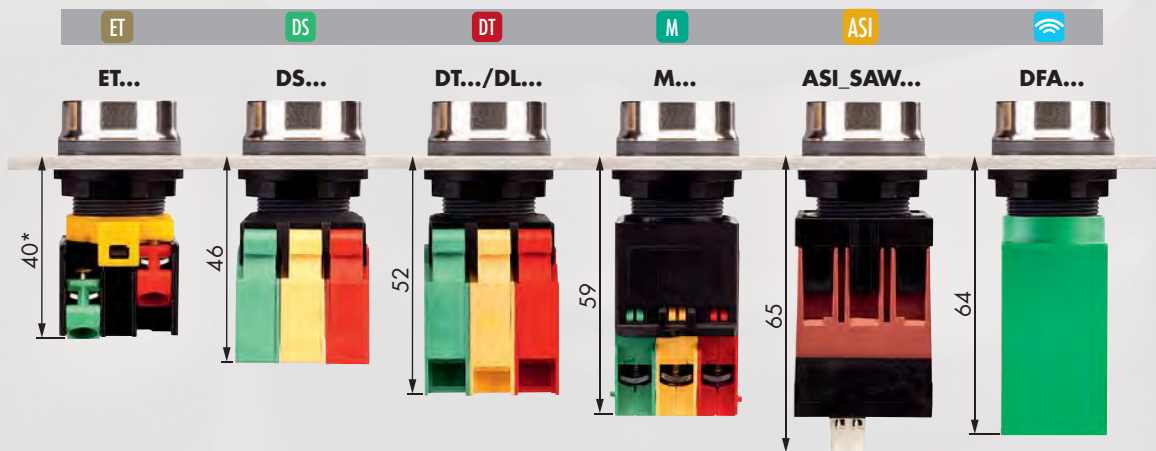

\* ETR2 61mm, ETLR 50mm, ETLR2 70mm, EL9R 36mm

## Cutout Dimensions

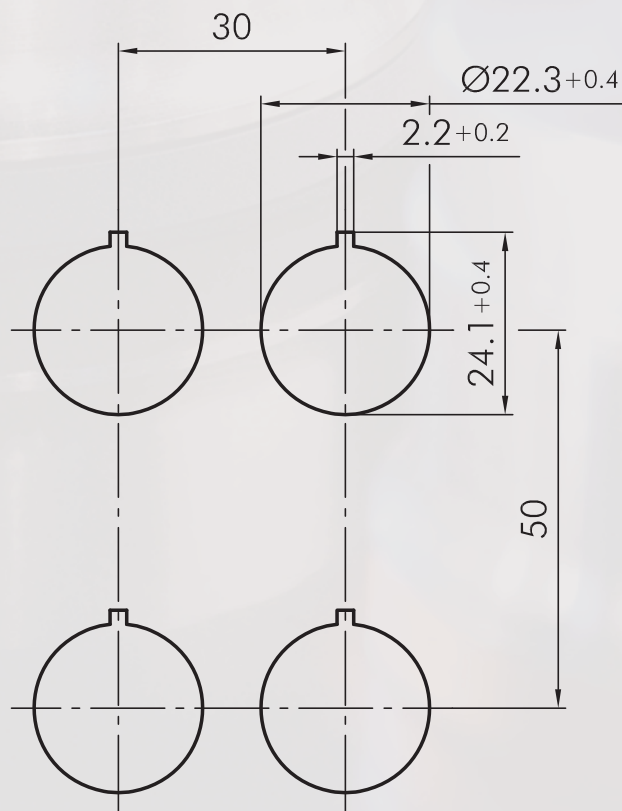

About Us

Control Units  
→ Actuators

Panel Mount Jacks

Bus Technology

Enclosures

Terminal Blocks

Pedal Switches







Limit Switches

Type Index

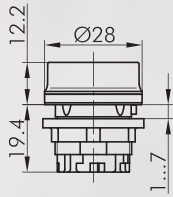
## Pushbutton Heads

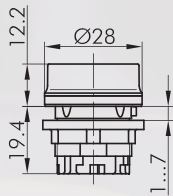
made of stainless steel V4A (1.4404)

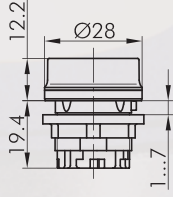
The housing/visible edging is supplied in green-GN, red-RT, blue-BL, yellow-GB, black-SW, white-WS or charcoal-DG. Add code letter to type number, e.g. RVAT\_RT.

Illustration	Dimensions	Description	Type
		<p><b>Pushbutton Head</b> laser printing on request suitable contact blocks</p> <p>DS DT ET M</p> <p>front bezel stainless steel, polished</p>	RVAT_...
		<p><b>Pushbutton Head with ring illumination</b> suitable contact blocks</p> <p>DS DT ET M</p> <p>front bezel stainless steel, polished</p>	RVATLR_...
		<p><b>Pushbutton Head with ring illumination and laser printing</b> incl. lens standard imprints see nameplates on pages #sbez# (please specify index number), special imprints on request</p> <p>DS DT ET M</p> <p>front bezel stainless steel, polished</p>	RVATLRL_...
		<p><b>Sealing Cap</b> made of silicone rubber, down to -50°C</p>	TK295









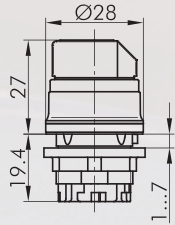

**Selector Switches (momentary/maintained)**

made of stainless steel V4A (1.4404)

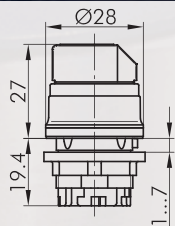
The housing (visible edging) is supplied in green-GN, red-RT, blue-BL, yellow-GB, black-SW, white-WS or charcoal-DG. Add code letter to type number, e.g. RVAWA\_RT.

I = Switching position

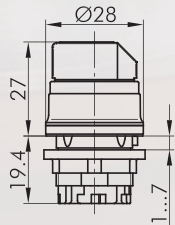
> = Spring return

Illustration	Dimensions	Description	Type
		<p><b>Selector Head, maintained</b></p> <p>suitable contact blocks  <span style="background-color: #00aaff; color: white; padding: 2px;">DS</span> <span style="background-color: #ff0000; color: white; padding: 2px;">DT</span> <span style="background-color: #008000; color: white; padding: 2px;">ET</span> <span style="background-color: #0000ff; color: white; padding: 2px;">M</span></p> <p>front bezel stainless steel, polished </p> <p>suitable contact blocks  <span style="background-color: #ff0000; color: white; padding: 2px;">DT</span> <span style="background-color: #008000; color: white; padding: 2px;">ET</span> <span style="background-color: #0000ff; color: white; padding: 2px;">M</span></p> <p>front bezel stainless steel, polished </p>	 <p><b>RVAWA_...</b></p> <p><b>RVAWB_...</b></p>
		<p><b>Selector Head, momentary</b></p> <p>suitable contact blocks  <span style="background-color: #ff0000; color: white; padding: 2px;">DT</span> <span style="background-color: #008000; color: white; padding: 2px;">ET</span> <span style="background-color: #0000ff; color: white; padding: 2px;">M</span></p> <p>front bezel stainless steel, polished </p>	 <p><b>RVASTB_...</b></p>
		<p><b>Selector Head, left maintained, right momentary</b></p> <p>suitable contact blocks  <span style="background-color: #ff0000; color: white; padding: 2px;">DT</span> <span style="background-color: #008000; color: white; padding: 2px;">ET</span> <span style="background-color: #0000ff; color: white; padding: 2px;">M</span></p> <p>front bezel stainless steel, polished </p>	 <p><b>RVAWC_...</b></p>

About Us

Control Units

Panel Mount Jacks

Bus Technology

Enclosures

Terminal Blocks

Pedal Switches

Limit Switches

Type Index

→ Actuators



### Key Switches (momentary/maintained)

made of stainless steel V4A (1.4)

The housing/visible edging and the luminous spot are supplied in green-GN, red-RT, blue-BL, yellow-GB, black-SW, white-WS or charcoal-DG. Add code letter to type number, e.g. RVASSA12E\_RT.

### Pilot Lights

I = Switching position

> = Spring return

○ = Key removable position

Illustration

Dimensions

Description

Type

IP65

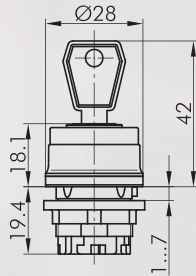

### Key Actuator, maintained

including two keys  
other lock types on request

suitable contact blocks

DT ET M

front bezel stainless steel, polished



RVASSA12E\_...

suitable contact blocks

DT ET M

front bezel stainless steel, polished



RVASSA13E\_...

suitable contact blocks

Wi DT ET M

front bezel stainless steel, polished

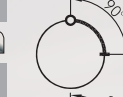

RVASSA14E\_...

suitable contact blocks

Wi DS DT ET M

front bezel stainless steel, polished



RVASSA15E\_...

suitable contact blocks

Wi DS DT ET M

front bezel stainless steel, polished



RVASSA17E\_...

suitable contact blocks

Wi DT ET M

front bezel stainless steel, polished



RVASSA18E\_...



### Spare Key (standard)

standard spare key, specify key number for special locks

ESE845

IP69K

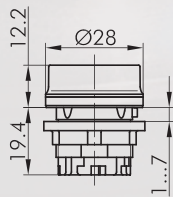

### Pilot Light Head



suitable lampholders

DS DT ET M

front bezel stainless steel, polished

RVAN\_...

**Accessories for Actuators**

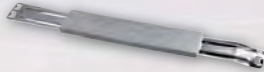
Illustration	Dimensions	Description	Type
		<b>Mounting Tool</b> with torque limitation for the series QUARTEX-R(-JUWEL), KOMBITAST-R-JUWEL, RONDEX, RONDEX-M, RVA, DUX-Basic, SHORTRON, jacks of the RONTRON-R/-Q-JUWEL series	<b>S22</b>
		<b>Mounting Tool Adapter with 1/4" connections</b> for mounting tools S16 and S22	<b>SRA</b>
		<b>Universal Lens Remover</b>	<b>USK</b>