



Front dimensions: 30 x 30 mm
Panel cut-out: Ø 22.3 mm
Front bezel height: 12 mm
Travel: 6 mm



QUARTEX-R



Product configurator



Overview QUARTEX-R series





01 Pushbutton Heads	page 258	07 Key Actuators	page 264
02 Emergency Stop Buttons	page 261	08 Pilot Lights	page 265
03 Mushroom Heads	page 261		
04 Knob Set for Rotary Switch / Potentiometer	page 262		
05 Selector Heads	page 262		
06 Toggle Heads	page 263		
		Contact Blocks / Lampholders	page 408

Housing Colour



 IP65 degree of protection

 6 mm operating travel

 illuminating option

 labelling option

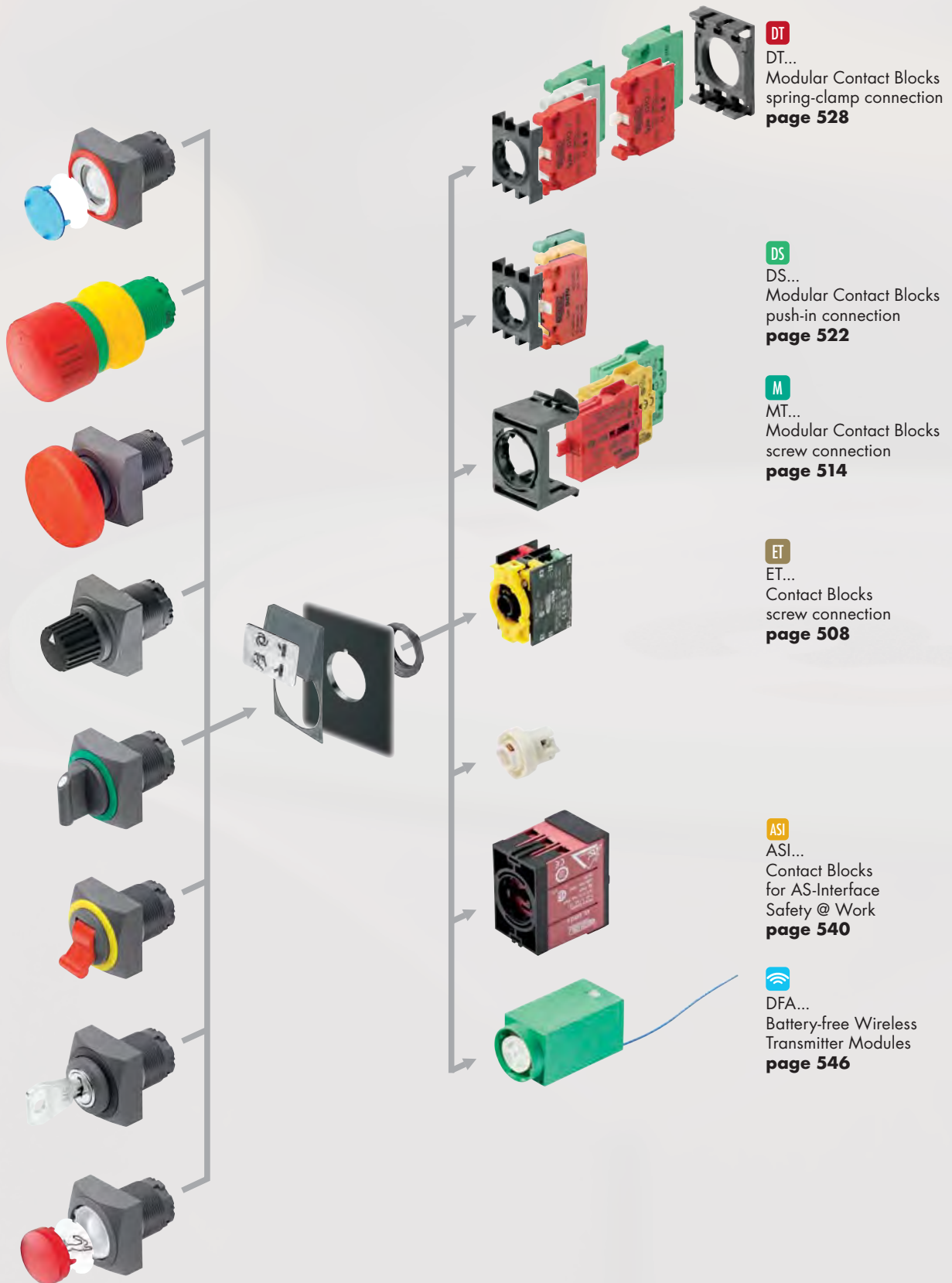

When combining the DT... contact blocks with key, selector and toggle heads, please add ..._497 to the actuator type reference!

Mounting Depth Dimensions

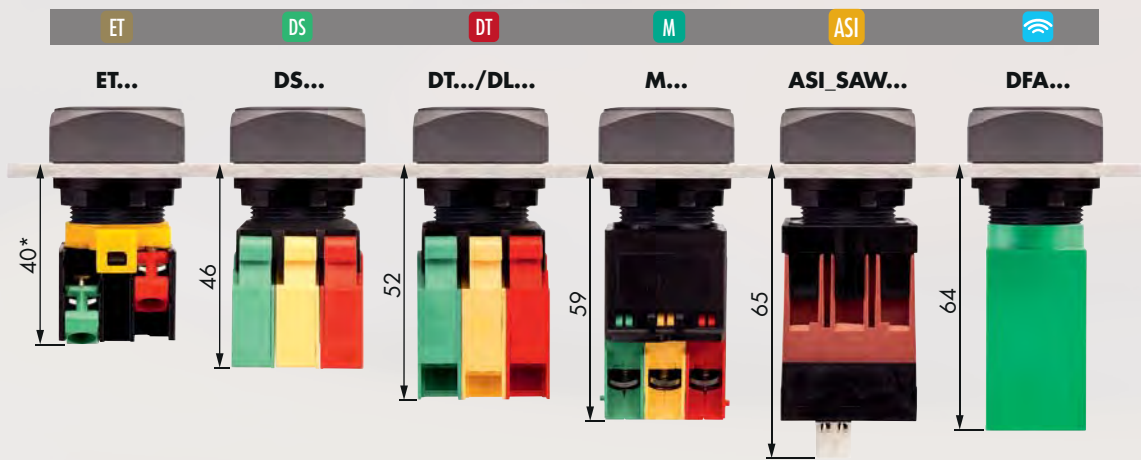

* ETR2 61mm, ETLR 50mm, ETLR2 70mm, EL9R 36mm

Cutout Dimensions

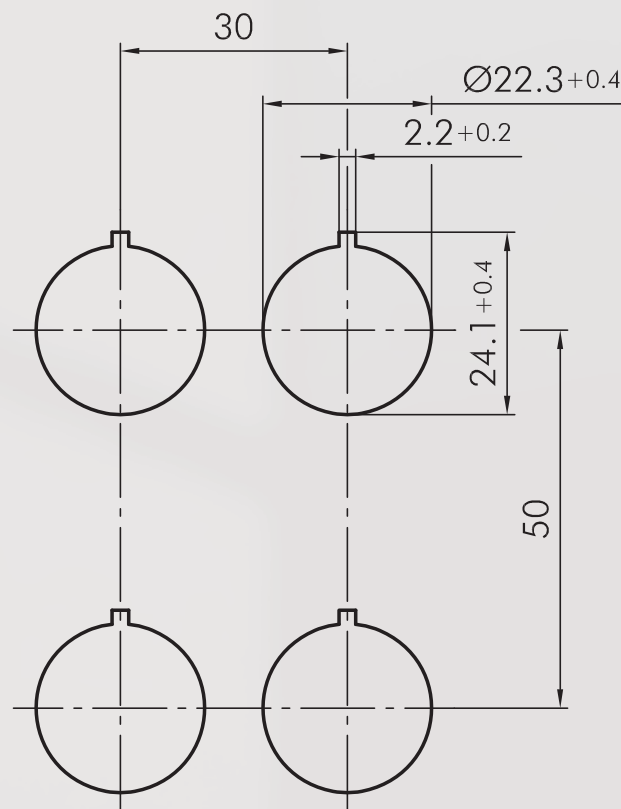

Mounting and Service Instructions

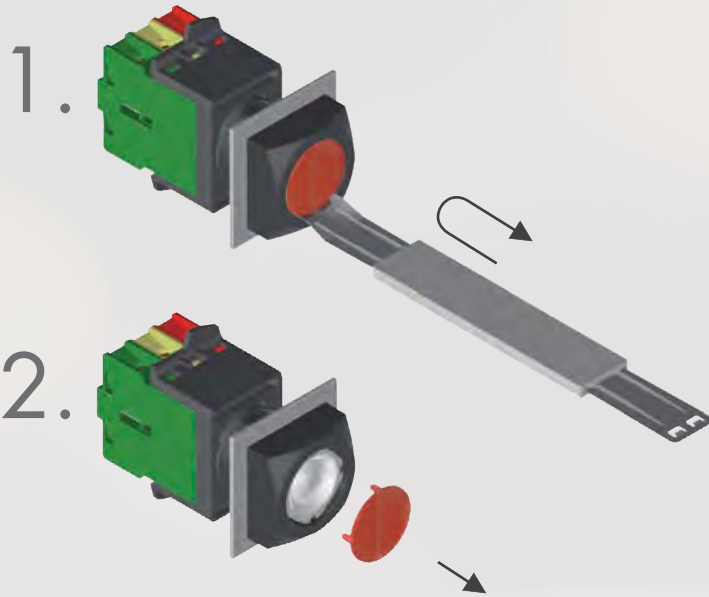

About Us

Control Units
→ Actuators

Panel Mount Jacks

Bus Technology

Enclosures

Terminal Blocks

Pedal Switches

Limit Switches

Type Index

QUARTEX-R

Ø 22.3 mm

made in germany



Pushbutton Heads

Front rings are supplied in dark-grey as a standard (QRT), also available in blue-BL, yellow-GB, green-GN, red-RT, white-WS and black-SW.

Add code letter to type number (e.g. QRT_RRT)

Lenses and nameplates to be ordered separately

Illustration

Dimensions

Description

Type

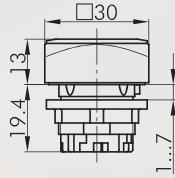

Pushbutton Head

suitable contact blocks



front bezel

charcoal



QRT...



Concave Lens, transparent

colour

blue



T26DBL

yellow



T26DGB

green



T26DGN

clear



T26DKL

red



T26DRT

opalwhite



T26DWS



Concave Lens, non-transparent

used in pushbuttons without inscription and illumination

colour

blue



T26DGBL

yellow



T26DGGB

green



T26DGGN

black



T26DGSW

red



T26DGR

white



T26DGWS



High Lens, transparent

colour

blue



KH23BL

yellow



KH23GB

green



KH23GN

clear



KH23KL

red



KH23RT

opalwhite



KH23WS



High Lens, non-transparent

used in pushbuttons without inscription and illumination

colour

blue



TG22GHBL

yellow



TG22GHGB

green



TG22GHGN

black



TG22GHSW

red



TG22GHRT

white



TG22GHWS

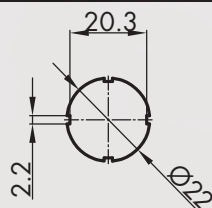

Nameplate with standard imprint

please specify index number (see nameplates on pages 404)

BSK...

About Us

Control Units

Actuators

Panel Mount Jacks

Bus Technology

Enclosures

Terminal Blocks

Pedal Switches

Limit Switches

Type Index

Pushbutton Heads

Front rings are supplied in dark-grey as a standard (QRTM), also available in blue-BL, yellow-GB, green-GN, red-RT, white-WS and black-SW.

Add code letter to type number (e.g. QRTM_RRT)

Illustration	Dimensions	Description	Type																		
		Nameplate with special imprint according to customer's specification	BSKB																		
		Blank Nameplate	BSKU																		
		Membrane Pushbutton Head with tightly closed, transparent silicone cap, down to -50° C	QRTM...																		
		suitable contact blocks front bezel charcoal																			
		Flat Lens, transparent colour <table border="0"> <tr> <td>blue</td> <td></td> <td>T20FBL</td> </tr> <tr> <td>yellow</td> <td></td> <td>T20FGB</td> </tr> <tr> <td>green</td> <td></td> <td>T20FGN</td> </tr> <tr> <td>clear</td> <td></td> <td>T20FKL</td> </tr> <tr> <td>red</td> <td></td> <td>T20FRT</td> </tr> <tr> <td>opalwhite</td> <td></td> <td>T20FWS</td> </tr> </table>	blue		T20FBL	yellow		T20FGB	green		T20FGN	clear		T20FKL	red		T20FRT	opalwhite		T20FWS	
blue		T20FBL																			
yellow		T20FGB																			
green		T20FGN																			
clear		T20FKL																			
red		T20FRT																			
opalwhite		T20FWS																			
		Nameplate with standard imprint Please specify index number (see nameplates on pages 404)	BSRX...																		
		Nameplate with special imprint according to customer's specification	BSRXB																		
		Blank Nameplate	BSRXU																		

Pushbutton Heads

Illustration

Dimensions

Description

Type

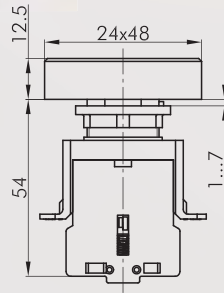

Double Pushbutton

fully assembled with modular contact blocks
ON-pushbutton green, 1NO
OFF-pushbutton red, 1NC
front bezel charcoal



LDT

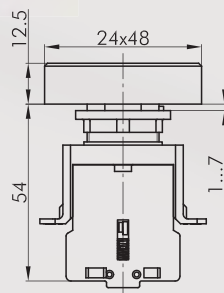

Illuminated Double Pushbutton

with central signal light
without lamp
fully assembled with modular contact blocks
ON-pushbutton green, 1NO
OFF-pushbutton red, 1NC
front bezel charcoal



LDTL

IP67



Sealing Cap

made of silicone rubber, down to -50°C

TK50S

About Us

Control Units

Actuators

Panel Mount Jacks

Bus Technology

Enclosures

Terminal Blocks

Pedal Switches

Limit Switches

Type Index

**Emergency Stops
Mushroom Heads**

Illustration

Dimensions

Description

Type



For further emergency stops, please refer to the chapter "Emergency-stop Heads" starting on page 366

The emergency-stop heads can also be supplied as latching mushroom heads with mushrooms in different colours.

IP65

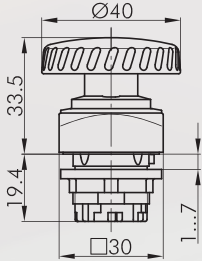

Mushroom Head, latch-type

other mushroom colours on request must be mounted onto yellow background!

foolproof	No
switching position indicator	No
anti-lock collar	No
release	twist
Standard	EN 60947-5-1, EN 60947-5-5, EN ISO 13850



suitable contact blocks

ASI DS DT ET M

mushroom head	red	
front bezel	charcoal	

QRV

IP65

6 mm

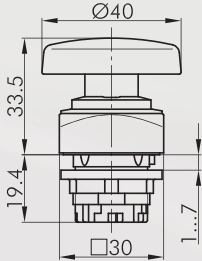

Mushroom Head, momentary

other mushroom colours on request

switching position indicator	No
anti-lock collar	No

suitable contact blocks

DS DT ET M

mushroom head	red	
front bezel	charcoal	

QRS

suitable contact blocks

DS DT ET M

mushroom head	black	
---------------	-------	--

QRS_SW.PILZ

QUARTEX-R

Ø 22.3 mm

made in germany



Knob Set for rotary switches

Front rings are supplied in dark-grey as a standard (QRDAU), also available in blue-BL, yellow-GB, green-GN, red-RT, white-WS and black-SW.

Add code letter to type number (e.g. QRDAURT)

Knob Set for potentiometers

Selector Switches (momentary/maintained)

I = Switching position

> = Spring return

Illustration

Dimensions

Description

Type

IP65

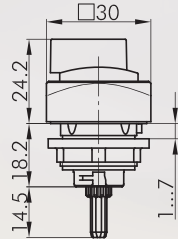

Knob Set for rotary switches, without inscription

for Kraus & Naimer types CG4 and CA4

other versions on request

front bezel charcoal



QRDAU...

IP65

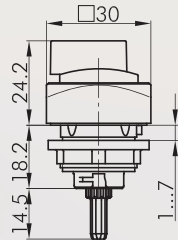

Knob Set for rotary switches, with inscription

for Kraus & Naimer types CG4 and CA4

other versions on request

front bezel charcoal



QRDAB...

IP65

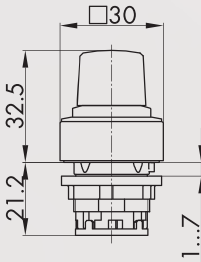

Knob Set for potentiometers

for potentiometers of 6 mm shaft dia. and thread M10 x 0.75. Delivery without potentiometer.

Shaft length: approx. 50 mm ± 2 mm, incl. fastening thread

front bezel charcoal



QRR...

IP65

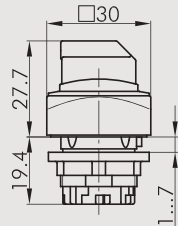

Selector Head, maintained

suitable contact blocks



front bezel charcoal



QRWA...

suitable contact blocks



front bezel charcoal



QRWB...



IP65

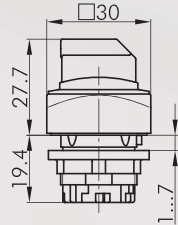

Selector Head, momentary

suitable contact blocks



front bezel charcoal



QRSTA...

suitable contact blocks



front bezel charcoal



QRSTB...



IP65

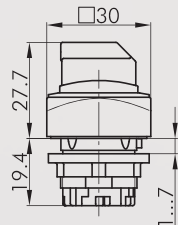

Selector Head, left maintained, right momentary

suitable contact blocks



front bezel charcoal



QRWC...



About Us

Control Units

Panel Mount Jacks

Bus Technology

Enclosures

Terminal Blocks

Pedal Switches

Limit Switches

Type Index











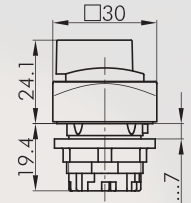









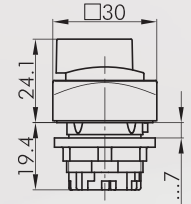



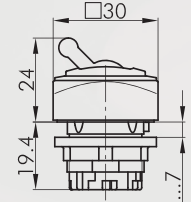

Selector Switches (momentary/maintained)

inclusive four small, transparent colour plates in red, yellow, green and blue

Toggle Heads

I = Switching position

> = Spring return

Illustration	Dimensions	Description	Type																				
		<p>Illuminated Selector Head, maintained inclusive four small, transparent colour plates in red, yellow, green and blue</p> <table border="0"> <tr> <td>suitable contact blocks</td> <td>DS</td> <td>DT</td> <td>ET</td> <td>M</td> </tr> <tr> <td>front bezel</td> <td>charcoal</td> <td></td> <td></td> <td></td> </tr> <tr> <td>suitable contact blocks</td> <td>DS</td> <td>DT</td> <td>ET</td> <td>M</td> </tr> <tr> <td>front bezel</td> <td>charcoal</td> <td></td> <td></td> <td></td> </tr> </table>	suitable contact blocks	DS	DT	ET	M	front bezel	charcoal				suitable contact blocks	DS	DT	ET	M	front bezel	charcoal				<p>QRWAL</p>  <p>QRWBL</p> 
suitable contact blocks	DS	DT	ET	M																			
front bezel	charcoal																						
suitable contact blocks	DS	DT	ET	M																			
front bezel	charcoal																						
<p>IP65</p> 		<p>Illuminated Selector Head, left maintained, right momentary</p> <table border="0"> <tr> <td>suitable contact blocks</td> <td>DS</td> <td>DT</td> <td>ET</td> <td>M</td> </tr> <tr> <td>front bezel</td> <td>charcoal</td> <td></td> <td></td> <td></td> </tr> </table>	suitable contact blocks	DS	DT	ET	M	front bezel	charcoal				<p>QRWCL</p> 										
suitable contact blocks	DS	DT	ET	M																			
front bezel	charcoal																						
<p>IP65</p> 		<p>Toggle Head red toggle (other colours on request)</p> <table border="0"> <tr> <td>suitable contact blocks</td> <td></td> <td>DS</td> <td>DT</td> <td>ET</td> <td>M</td> </tr> <tr> <td>knob colour</td> <td>red</td> <td></td> <td></td> <td></td> <td></td> </tr> <tr> <td>front bezel</td> <td>charcoal</td> <td></td> <td></td> <td></td> <td></td> </tr> </table>	suitable contact blocks		DS	DT	ET	M	knob colour	red					front bezel	charcoal					<p>QRK...</p>		
suitable contact blocks		DS	DT	ET	M																		
knob colour	red																						
front bezel	charcoal																						

QUARTEX-R

Ø 22.3 mm

Key Switches (momentary/maintained)

Front rings are supplied in dark-grey as a standard QRSSA12E), also available in blue-BL, yellow-GB, green-GN, red-RT, white-WS and black-SW.
Add code letter to type number (e.g. QRSSAA12E_RRT)

- I = Switching position
- > = Spring return
- = Key removable position

Illustration

Dimensions

Description

Type

IP65

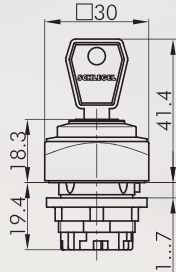

Key Actuator, maintained

including two keys
other lock types on request

suitable contact blocks

DT ET M

front bezel charcoal

suitable contact blocks

DT ET M

front bezel charcoal

suitable contact blocks

DS DT ET M

front bezel charcoal

suitable contact blocks

DS DT ET M

front bezel charcoal

suitable contact blocks

DS DT ET M

front bezel charcoal

suitable contact blocks

DS DT ET M

front bezel charcoal



QRSSA12E...



QRSSA13E...



QRSSA14E...



QRSSA15E...



QRSSA17E...



QRSSA18E...

IP65

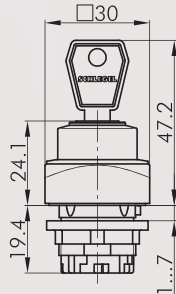

Key Actuator, momentary

suitable contact blocks

DT ET M

front bezel charcoal

suitable contact blocks

DS DT ET M

front bezel charcoal



QRSSA23E...



QRSSA27E...

IP65

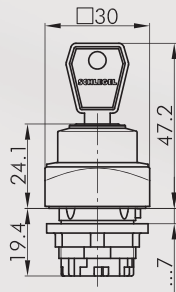

Key Actuator, left maintained, right momentary

suitable contact blocks

DT ET M

front bezel charcoal



QRSSA24E...



Spare Key (standard)

standard spare key, specify key number for special locks

ESE845

About Us

Control Units

Actuators

Panel Mount Jacks

Bus Technology

Enclosures

Terminal Blocks

Pedal Switches

Limit Switches











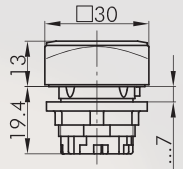













Type Index

Pilot Lights

Front rings are supplied in dark-grey as a standard (QRN), also available in blue-BL, yellow-GB, green-GN, red-RT, white-WS and black-SW.

Add code letter to type number (e.g. QRN_RRT).

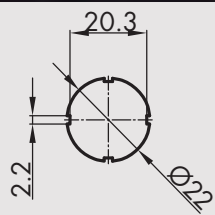
Lenses and nameplates to be ordered separately

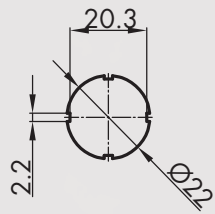
Illustration	Dimensions	Description	Type
		Pilot Light Head suitable lampholders DS DT ET M front bezel charcoal	QRN...
		Convex Lens colour	blue  KF23BL yellow  KF23GB green  KF23GN clear  KF23KL red  KF23RT opalwhite  KF23WS
		High Lens, transparent colour	blue  KH23BL yellow  KH23GB green  KH23GN clear  KH23KL red  KH23RT opalwhite  KH23WS
		Concave Lens, transparent colour	blue  T26DBL yellow  T26DGB green  T26DGN clear  T26DKL red  T26DRT opalwhite  T26DWS
		Nameplate with standard imprint please specify index number (see nameplates on pages 404)	BSK...
		Nameplate with special imprint according to customer's specification	BSKB

About Us

Control Units

Panel Mount Jacks

Bus Technology

Enclosures

Terminal Blocks

Pedal Switches

Limit Switches

Type Index

→ Actuators

Accessories for Actuators

Illustration

Dimensions

Description

Type

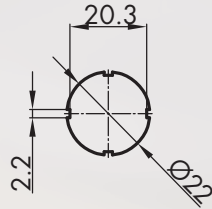

Blank Nameplate

BSKU



Mounting Tool

S22

with torque limitation
for the series QUARTEX-R(-JUWEL), KOMBITAST-R-JUWEL,
RONDEX, RONDEX-M, RVA, DUX-Basic, SHORTRON, jacks of
the RONTRON-R/-Q-JUWEL series



Mounting Tool Adapter with 1/4" connections

SRA

for mounting tools S16 and S22

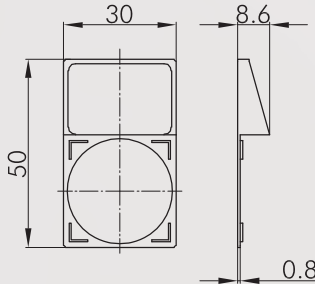

External Nameplate Holder

for outside marking of the actuators of the QUARTEX-R series,
accepts self-adhesive nameplates

colour

charcoal



QRABT



Self-adhesive Nameplate, laser-printed

BZ23G

Inscription according to customer's specification
Dimensions: 19 x 27 mm



Self-adhesive Nameplate blank

BZ23U

Dimensions: 19 x 27 mm



Self-adhesive Nameplate with standard imprint

BZ23B...

Please specify index no.
(see nameplates on page 404)
Dimensions: 19 x 27 mm



Yellow Nameplate

self-adhesive PVC foil
printing on request
outer dia. 75 mm
for mounting dia. 22 mm



colour

yellow



NAS_22

Accessories for Actuators

Illustration	Dimensions	Description	Type
		Yellow Nameplate with quadrilingual imprint self-adhesive PVC foil outer dia. 75 mm for mounting dia. 22 mm colour yellow	NAS_22_548
		Universal Lens Remover	USK
		Dummy to close unused mounting apertures colour charcoal	BVQR

About Us

Control Units
→ Actuators

Panel Mount Jacks

Bus Technology

Enclosures

Terminal Blocks

Pedal Switches

Limit Switches

Type Index