



Front dimensions: \varnothing 28 mm
Panel cut-out: \varnothing 22.3 mm
Front bezel height: 2 mm
Travel: 2.3 mm / 1.8 mm



Product configurator



SHORTTRON

Overview - SHORTRON series

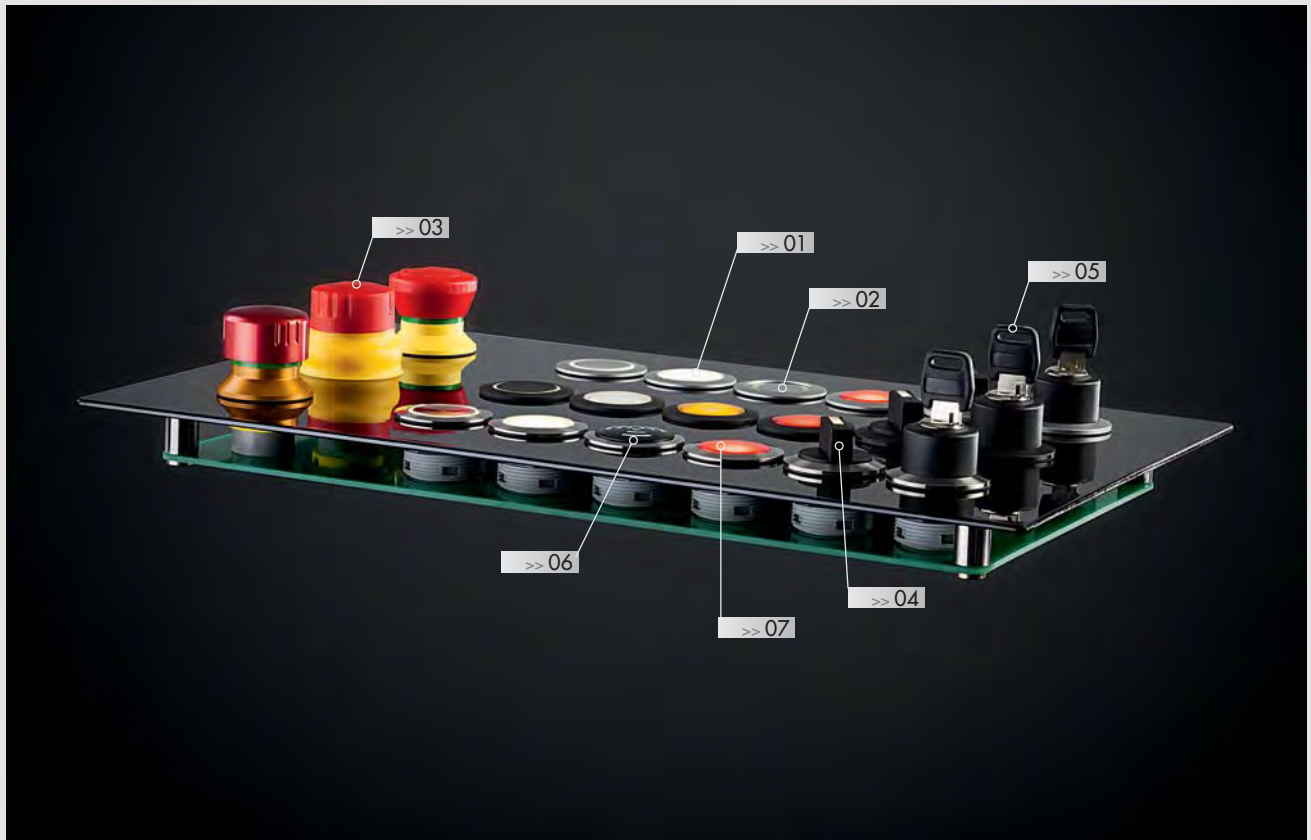

01 Pushbuttons	page 134	05 Key Switches	page 150
02 Capacitive Pushbuttons	page 143	06 Buzzers	page 152
03 Emergency-stop Buttons	page 144	07 Pilot Lights	page 153
04 Selector Switches	page 146		

Housing Colour (silver-coloured, black, polished stainless steel)



IP65 degree of protection

2.3mm operating travel

 illuminating option

 labelling option



Mounting Faston Clamp 2.8x0.8mm



Mounting Depth Dimensions

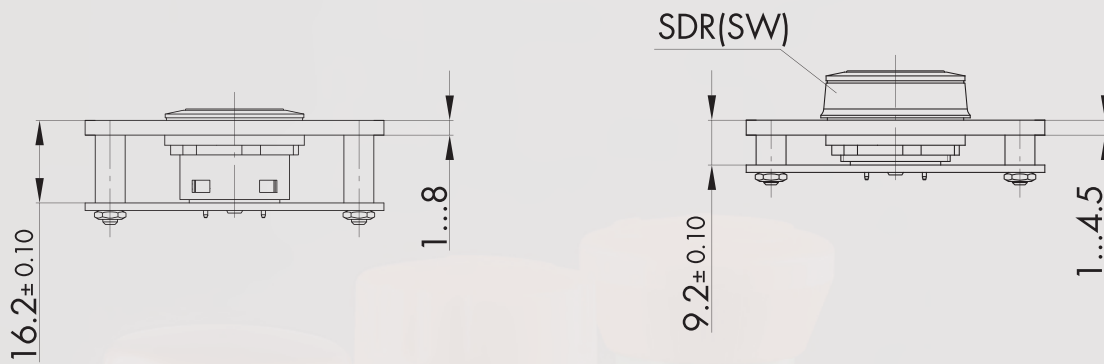

Cutout Dimensions

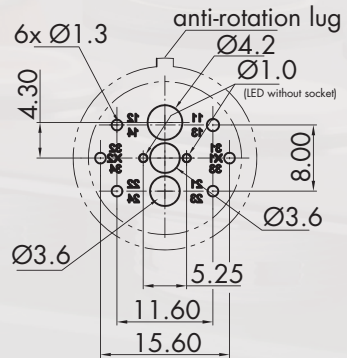
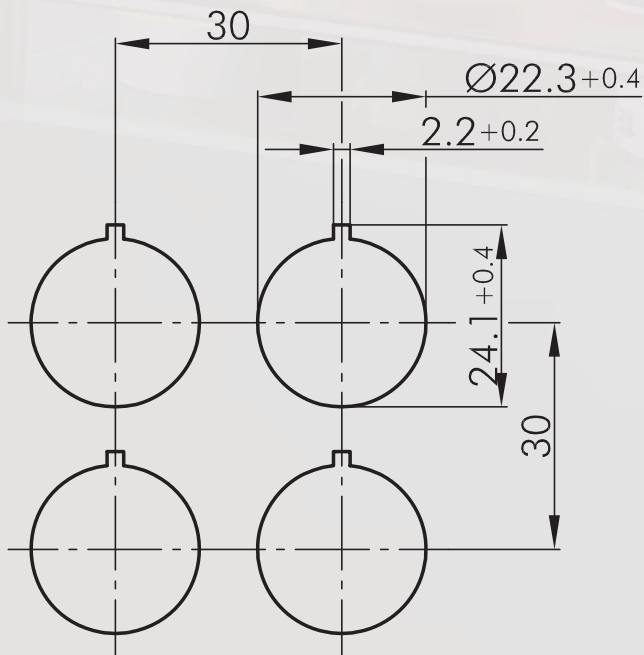

Component side view

Contact assignment: see wiring scheme of the relevant types

PCT...

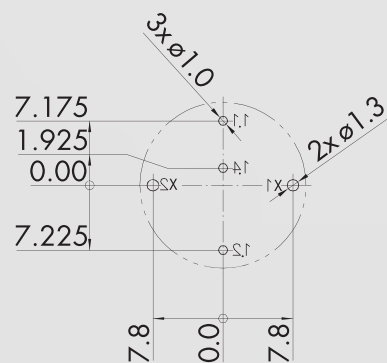

General Data

Type Reference:	S(VA)(SW)(T)(TLR)(WA)(WB)(SSA...)(N)(STA)(STB)(L)(I)(II)(O)(OO)(OI)(P)(LAU)
Description:	Short-stroke Pushbutton with integrated contact block, flat/high version, with Faston or PCB-mount terminals
Approvals:	CCC, CE, ENEC10, VDE, CE
Nature of contact:	2NC / 1NC+1NO / 2 NO / 1NO / 1NC
Degree of protection:	IP65 / IP67 (T, TLR, N) IP65 (SSA, STA, STB, WA, WB)
Operation travel:	2.3 mm
Connection type:	Faston terminals 2.8x0.8 mm / PCB-mount terminals
Max. storage temperature:	-40°C ... 80°C
Max. operating temperature:	-25°C ... 70°C
Mechanical life:	1 m switching cycles (T, TLR) 30,000 (WA, WB, STA)
Electrical life (rated load):	1m switching cycles (T, TLR) 30,000 (WA, WB, STA)
Contact resistance NO:	< 20 mOhm
Contact resistance NC:	< 20 mOhm
Min. current:	1 mA (under laboratory conditions)
Min. voltage:	5 V
Bouncing time NO:	< 10 ms
Bouncing time NC:	< 10 ms
Positive opening contact:	acc. to EN60947-5-1, appendix. K

Electrical data acc. to IEC/EN 60947-5-1 (VDE 0660 Sect. 200)

	alternate current	direct current
Utilisation category:	AC15 B300	DC13 Q300
Rated insulation voltage Ui:	250 V	250 V
Rated operating voltage Ue:	240V / 120V	250V / 125V / 60V / 24V
Rated operating current Ie:	1.5A / 3A	0.27 A / 0.55 A / 1 A / 2 A
Breaking capacity:	10Ie	1,1Ie
Continuous thermal current:	5A	

Electrical data acc. to IEC/EN 61058-1 (VDE 0630 Sect. 1)

Rated voltage Ue:	250 V~
Rated current Ie:	6(4) A

Technical Data - Lamp

Lamp socket:	with integrated white 3 mm LED
Max. lamp voltage:	30 V AC/DC
Max. lamp output:	14mA (at 24 V DC)
Definition:	X1...anode, X2...cathode

Additional Data

Mounting aperture:	22.3mm
Tightening torque (mounting nut):	1.5 ... 1.9 Nm
Mounting position:	any
Standards:	EN 60947-5-1, EN 61058

Electrical Features - 5µm gold-plating, type addition ...AU

Operational voltage:	20mV ... 42V AC/DC
Switching current:	1mA ... 100mA
Contact resistance (new state):	< 50 mOhm

Note

T...pushbutton, TLR...pushbutton with ring illumination, N...pilot light
T...key-operated switch
STA, STB...momentary selector switch
WA, WB...maintained selector switch

Standard version with Faston terminals 2.8x0.8mm
(P)=with PCB-mount terminals (Z)=base-plate-mounted version with PCB-mount terminals

DC13: > 100,000 switching cycles

versions with Faston terminals: use partially or fully insulated Faston clamps
illuminated versions (24 V LED): overvoltage category II (2.5kV), pollution degree 2
versions with three contacts: overvoltage category II (2.5kV), pollution degree 2

This data sheet is not applicable for the types S..C..* (tactile versions of the Shortron range)

Mounting depth of the base-plate versions

Flat mounting:	16.2 mm
Mounting with spacer ring:	9.2 mm

General Data

Type Reference:	S(VA)(SW)C(T)(TLR)(...)(L)(F)
Description:	Tactile Short-stroke Pushbutton with integrated contact block, flat/high version, with Faston or PCB-mount terminals
Approvals:	CCC, CE, ENEC10, VDE, CE
Nature of contact:	1 inverter
Degree of protection:	IP65 / IP67
Operation travel:	2.3 mm
Connection type:	Faston terminals 2.8x0.8 mm / PCB-mount terminals
Max. storage temperature:	-40°C ... 80°C
Max. operating temperature:	-25°C ... 70°C
Mechanical life:	1 m switching cycles
Electrical life (rated load):	1m operations
Contact resistance NO:	< 50 mOhm (new state)
Contact resistance NC:	< 100 mOhm (new state)
Bouncing time NO:	< 10 ms
Bouncing time NC:	< 10 ms

Technical Data - Lamp

Lamp socket:	with integrated white 3 mm LED
Max. lamp voltage:	30 V AC/DC
Max. lamp output:	14mA (at 24 V DC)
Definition:	X1...anode, X2...cathode

Additional Data

Mounting aperture:	22.3mm
Tightening torque (mounting nut):	1.5 ... 1.9 Nm
Mounting position:	any
Standards:	EN 61058-1

Electrical Features

Rated voltage:	20mV ... 48V AC/DC
Rated current:	0.01mA ... 100mA

Note

Standard version with PCB-mount terminals
(F)= with Faston terminals 2.8x0.8mm (Z)=base-plate-mounted version with PCB-mount terminals

Mounting depth of the base-plate versions

Flat mounting:	16.2 mm
Mounting with spacer ring:	9.2 mm

Electrical data acc. to IEC/EN 60947-5-1 (VDE 0660 Sect. 200)

	alternate current	direct current
Utilisation category:	AC12	DC12
Rated insulation voltage Ui:	60V	60V
Rated operating voltage Ue:	48V	48V
Rated operating current Ie:	0.1A	0.1A
Continuous thermal current:	100mA	100mA

Remark

GB14048.5-2008 (IEC60947-5-1)

General Data

Type Reference:	SVACFT(L)(X)(F)(P)
Description:	Single Membrane Pushbutton with integrated contact block, with Faston or PCB-mount terminals
Approvals:	CE, DGUV_Test
Nature of contact:	1 inverter
Degree of protection:	IP66 / IP67 / IP69K
Operation travel:	1.8 mm
Connection type:	Faston terminals 2.8x0.8 mm / PCB-mount terminals
Max. storage temperature:	-40°C ... 80°C
Max. operating temperature:	-25°C ... 70°C
Mechanical life:	1 m switching cycles (20°C)
Contact resistance NO:	< 50 mOhm (new state)
Contact resistance NC:	< 100 mOhm (new state)
Bouncing time NO:	< 10 ms
Bouncing time NC:	< 10 ms

Technical Data - Lamp

Lamp socket:	with integrated white 3 mm LED
Max. lamp voltage:	30 V AC/DC
Max. lamp output:	14mA (at 24 V DC)
Definition:	X1...anode, X2...cathode

Additional Data

Mounting aperture:	22.3mm
Tightening torque (mounting nut):	1.5 ... 1.9 Nm
Mounting position:	any
Standards:	EN 61058-1

Electrical Features

Rated voltage:	20mV ... 48V AC/DC
Rated current:	0.01mA ... 100mA

Note

SVACFT(L)(X)(F)(P)(Z) ()...optional
(L) = illuminating option
(X) = foil ring colours: standard=black (W=white, R=red, Y=yellow, G=green, B=blue)
(F) = with Faston terminals 2.8x0.8mm
(P) = with PCB-mount terminals
(Z) = base-plate mounted version with PCB-mount terminals

General Data

Type Reference:	FRVKAL(O)(OO)(OOO)(OI)(OOI)(OII)(P)(_AU)
Description:	Emergency Stop, aluminium version, foolproof
Approvals:	CE, TÜV_Süd, Zwangsöffnung, UR
Nature of contact:	1NC / 2NC / 3 NC / 1 NC+1NO / 2NC+1NO / 1NC+2NO
Degree of protection:	IP65 / IP67
Connection type:	Faston terminals 2.8x0.8 mm / PCB-mount terminals
Contact material:	AgNi / AgNi, gold-plated 5µm
Max. storage temperature:	-40°C ... 80°C
Max. operating temperature:	-25°C ... 70°C
Mechanical life:	50,000
Electrical life (rated load):	50,000 at rated load
Contact resistance NO:	< 50 mOhm (new state)
Contact resistance NC:	< 50 mOhm (new state)
Bouncing time NO:	< 10 ms
Bouncing time NC:	< 10 ms
Positive opening contact:	acc. to EN60947-5-1, appendix. K

Electrical data acc. to IEC/EN 60947-5-1 (VDE 0660 Sect. 200)

Utilisation category:	alternate current	direct current
Rated insulation voltage Ui:	AC15 B300	DC13 Q300
Rated operating voltage Ue:	250 V	250 V
Rated operating current Ie:	240V / 120V	250V / 125V / 60V / 24V
Breaking capacity:	1.5A / 3A	0.27 A / 0.55 A / 1 A / 2 A
Continuous thermal current:	10Ie	1,1Ie
	5A	

Additional Data

Mounting aperture:	22.3mm
Tightening torque (mounting nut):	1.3 ... 1.9 Nm
Release:	twist release, left or right
Mounting position:	any
Standards:	EN 60947-5-1, EN 60947-5-5, EN ISO 13850
Pollution degree :	3

Reliability Data

Ld:	20% (NC)
B10d:	250.000

Note

with switching position indicator

Electrical Features - 5µm gold-plating (type addition ...AU)	
Switching voltage	20mV ... 42V AC/DC
Switching current	1mA ... 250mA

For the version with Faston terminals use partially or fully insulated Faston clamps.
Version with 3 contacts: overvoltage category II (2.5 kV), pollution degree 2

Data acc. to UL508

Ratings:	silver: B300, 24Vdc/3A gold: 24Vdc/100mA
----------	--

General Data

Type Reference:	FRVK(P)(L)(O)(OO)(OOO)(OI)(OOI)(OII)(Z)(LZ)(P)(L)AU
Description:	Emergency Stop, foolproof
Approvals:	CCC, CE, TÜV_Süd, Zwangsöffnung, UR
Nature of contact:	1NC / 2NC / 3 NC / 1 NC+1NO / 2NC+1NO / 1NC+2NO
Degree of protection:	IP65 / IP67
Connection type:	Faston terminals 2.8x0.8 mm / PCB-mount terminals
Contact material:	AgNi / AgNi, gold-plated 5µm
Max. storage temperature:	-40°C ... 80°C
Max. operating temperature:	-25°C ... 70°C
Mechanical life:	50,000
Electrical life (rated load):	50,000 at rated load
Contact resistance NO:	< 50 mOhm (new state)
Contact resistance NC:	< 50 mOhm (new state)
Bouncing time NO:	< 10 ms
Bouncing time NC:	< 10 ms
Positive opening contact:	acc. to EN60947-5-1, appendix. K

Electrical data acc. to IEC/EN 60947-5-1 (VDE 0660 Sect. 200)

Utilisation category:	alternate current	direct current
Rated insulation voltage Ui:	AC15 B300	DC13 Q300
Rated operating voltage Ue:	250 V	250 V
Rated operating current Ie:	240V / 120V	250V / 125V / 60V / 24V
Breaking capacity:	1.5A / 3A	0.27 A / 0.55 A / 1 A / 2 A
Continuous thermal current:	10Ie	1,1Ie
	5A	

Technical Data - Lamp

Lamp socket:	none, with integrated 3 mm LED
Max. lamp voltage:	30 V AC/DC
Max. lamp output:	4 mA at 24 V DC)
Definition:	X1...anode, X2...cathode

Additional Data

Mounting aperture:	22.3mm
Tightening torque (mounting nut):	1.3 ... 1.9 Nm
Release:	twist release, left or right
Mounting position:	any
Standards:	EN 60947-5-1, EN 60947-5-5, EN ISO 13850
Ld:	20% (NC)
B10d:	250.000
Pollution degree :	3

Note

with switching position indicator

Electrical Features - 5µm gold-plating (type addition ...AU)	
Switching voltage	20mV ... 42V AC/DC
Switching current	1mA ... 250mA

For the version with Faston terminals use partially or fully insulated Faston clamps.
Illuminated version (24V-LED): overvoltage category II (2.5kV), pollution degree 2
Version with 3 contacts: overvoltage category II (2.5 kV), pollution degree 2

FRVKP...	emergency stop for hygienic areas
Approvals:	CE, DGUV-Test
Mechanical life:	20,000 (20°C)
	>6050 (-25°C)
	>6050 (+70°C)
B10d/Ld:	150,000/20% (20°C)
FRVK...(Z)	...emergency stop for base-plate mounting
FRVK...(LZ)	...emergency stop for base-plate mounting with height compensation to use the Shortron series
Approvals:	CE
Snap-fit the corresponding contact block (PTS...) to the actuator neck.	
Spacer sleeves ensure the correct distance between PCB and mounting plate. Screws must be secured against loosening.	

Pushbutton Heads

Lenses and nameplates to be ordered separately.
Type addition for gold-plated contacts *_AU* (e.g. STLOI_AU)





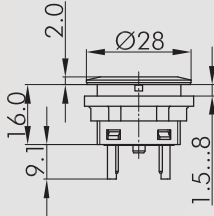

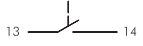
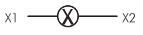
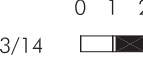
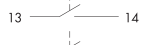

Illustration

Dimensions

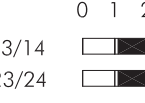

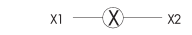
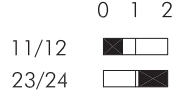
Illuminated Pushbutton



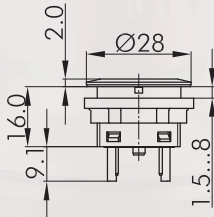

incl. white LED
Faston terminals 2.8x0.8 mm

	  	  	  
<i>front bezel</i>	1NO	2NO	1NC + 1NO
silver-coloured 	STLI	STLII	STLOI
black 	SSWTLI	SSWTLII	SSWTLOI
stainless steel, polished 	SVATLI	SVATLII	SVATLOI

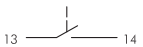
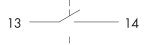
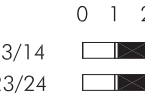
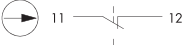
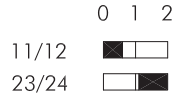

Pushbutton

Faston terminals 2.8x0.8 mm

		 	 
<i>front bezel</i>	1NO	2NO	1NC + 1NO
silver-coloured 	STI	STII	STOI
black 	SSWTI	SSWTII	SSWTOI
stainless steel, polished 	SVATI	SVATII	SVATOI

Pushbutton Heads

Lenses and nameplates to be ordered separately.

Illustration

Dimensions



Flat Lens, transparent

colour	blue		T22RRBL
	yellow		T22RRGB
	green		T22RRGN
	clear		T22RRKL
	red		T22RRRT
	opalwhite		T22RRWS



High Lens, transparent

colour	blue		T22HRRBL
	yellow		T22HRRGB
	green		T22HRRGN
	clear		T22HRRKL
	red		T22HRRRT
	opalwhite		T22HRRWS



Flat Lens, non-transparent

colour	blue		T22RRGBL
	yellow		T22RRGGB
	green		T22RRGGN
	black		T22RRGSW
	red		T22RRGRT
	white		T22RRGWS



Blank Nameplate

BSRRU



Nameplate with standard imprint

BSRR...

Please specify index number (see nameplates on pages 404)

Nameplate with special imprint

BSRRB

according to customer's specification

IP67



Sealing Cap

TK28S

made of silicone rubber, down to -50°C

Pushbutton Heads

Type addition for gold-plated version _AU (e. g. STLRWOI_AU)

Illustration

Dimensions

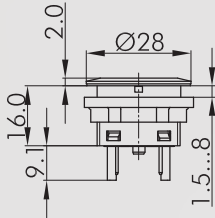

Pushbutton with ring illumination

incl. lens and white LED

Faston terminals 2.8x0.8 mm

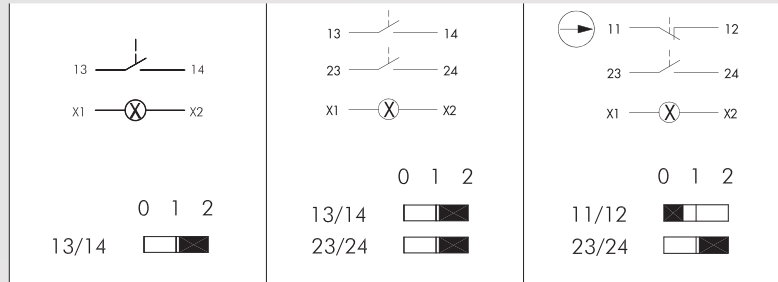

front bezel	illuminated ring	1NO	2NO	1NC + 1NO
silver-coloured	white	STLRWI	STLRWII	STLRWOI
	red	STLRRI	STLRRII	STLRROI
	green	STLRGI	STLRGII	STLRGOI
	yellow	STLRYI	STLRYII	STLRYOI
	blue	STLRBI	STLRBII	STLRBOI
black	white	SSWTLRWI	SSWTLRWII	SSWTLRWOI
	red	SSWTLRRI	SSWTLRRII	SSWTLRROI
	green	SSWTLRGI	SSWTLRGII	SSWTLRGOI
	yellow	SSWTLRYI	SSWTLRYII	SSWTLRYOI
	blue	SSWTLRBI	SSWTLRBII	SSWTLRBOI
stainless steel, polished	white	SVATLRWI	SVATLRWII	SVATLRWOI
	red	SVATLRRI	SVATLRRII	SVATLRROI
	green	SVATLRGI	SVATLRGII	SVATLRGOI
	yellow	SVATLRYI	SVATLRYII	SVATLRYOI
	blue	SVATLRBI	SVATLRBII	SVATLRBOI

Pushbutton Heads

Type addition for gold-plated version _AU (e. g. STLRWOI..._AU)

Illustration

Dimensions

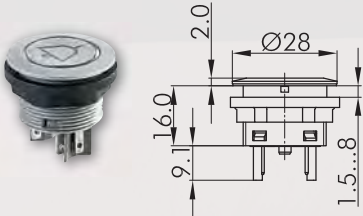

Pushbutton with ring illumination and inscription

incl. lens and white LED,
standard imprints see nameplates on page 404 (please specify index no.),
special inscription on request

Faston terminals 2.8x0.8 mm

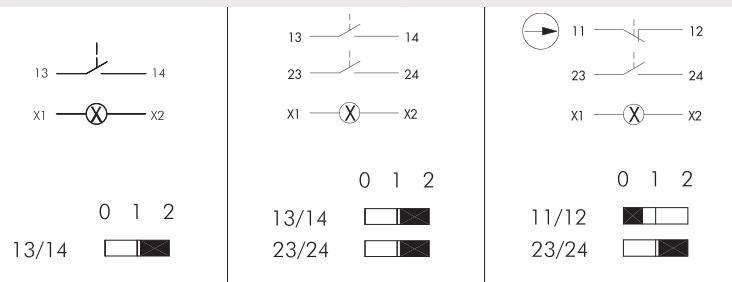

front bezel	illuminated ring	1NO	2NO	1NC + 1NO
silver-coloured	white	STLRWI...	STLRWII...	STLRWOI...
	red	STLRRI...	STLRRII...	STLRROI...
	green	STLRGI...	STLRGII...	STLRGOI...
	yellow	STLRYI...	STLRYII...	STLRYOI...
	blue	STLRBI...	STLRBII...	STLRBOI...
stainless steel, polished	white	SVATLRWI...	SVATLRWII...	SVATLRWOI...
	red	SVATLRRI...	SVATLRRII...	SVATLRROI...
	green	SVATLRGI...	SVATLRGII...	SVATLRGOI...
	yellow	SVATLRYI...	SVATLRYII...	SVATLRYOI...
	blue	SVATLRBI...	SVATLRBII...	SVATLRBOI...

About Us

Control Units
→ Actuators

Panel Mount Jacks

Bus Technology

Enclosures

Terminal Blocks

Pedal Switches

Limit Switches

Type Index

Pushbutton Heads

Illustration

Dimensions

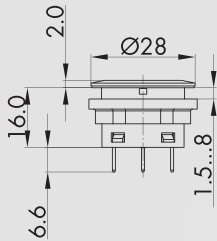

Tactile Pushbutton, illuminated

incl. white LED, gold-plated contacts
Faston terminals 2.8x0.8 mm

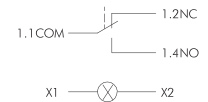

front bezel		1 inverter
silver-coloured		SCTLF
black		SSWCTLF
stainless steel, polished		SVACTLF

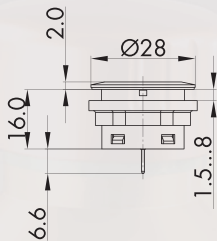

Tactile Pushbutton

gold-plated contacts
Faston terminals 2.8 mm

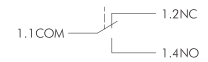

front bezel		1 inverter
silver-coloured		SCTF
black		SSWCTF
stainless steel, polished		SVACTF

Pushbutton Heads

Illustration

Dimensions



Domed Lens, transparent

colour	blue		T22DRRBL
	yellow		T22DRRGB
	green		T22DRRGN
	clear		T22DRRKL
	red		T22DRRRT
	opalwhite		T22DRRWS



Flat Lens, transparent

colour	blue		T22RRBL
	yellow		T22RRGB
	green		T22RRGN
	clear		T22RRKL
	red		T22RRRT
	opalwhite		T22RRWS



High Lens, transparent

colour	blue		T22HRRBL
	yellow		T22HRRGB
	green		T22HRRGN
	clear		T22HRRKL
	red		T22HRRRT
	opalwhite		T22HRRWS



Flat Lens, non-transparent

colour	blue		T22RRGBL
	yellow		T22RRGGB
	green		T22RRGGN
	black		T22RRGSW
	red		T22RRGRT
	white		T22RRGWS



Blank Nameplate

BSRRU



Nameplate with standard imprint

BSRR...

Please specify index number (see nameplates on pages 404)



Nameplate with special imprint

BSRRB

according to customer's specification

IP67



Sealing Cap

TK28S

made of silicone rubber, down to -50°C

Pushbutton Heads

Illustration

Dimensions

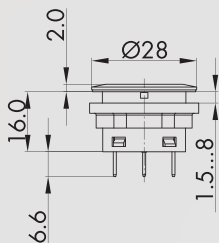

Tactile Pushbutton with ring illumination

incl. white LED, with gold-plated contacts

Faston terminals 2.8x0.8 mm

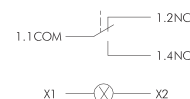

front bezel	illuminated ring	1 inverter
silver-coloured	white	SCTLRWF
	red	SCTLRRF
	green	SCTLRGF
	yellow	SCTLRYF
	blue	SCTLRBF
black	white	SSWCTLRWF
	red	SSWCTLRRF
	green	SSWCTLRGF
	yellow	SSWCTLRYF
	blue	SSWCTLRBF
stainless steel, polished	white	SVACTLRWF
	red	SVACTLRRF
	green	SVACTLRGF
	yellow	SVACTLRYF
	blue	SVACTLRBF

Pushbutton Heads

Illustration

Dimensions

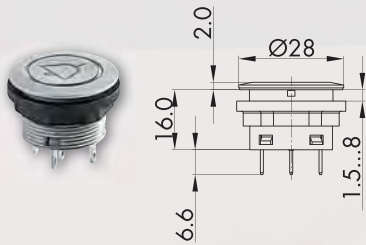

Tactile Pushbutton with ring illumination and laser printing

incl. lens and white LED,
standard imprints see nameplates on page 404
(please specify index no.),
special inscription on request
Faston terminals 2.8x0.8 mm

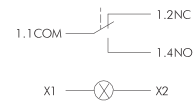

front bezel	illuminated ring	1 inverter
silver-coloured	white	SCTLRWF...
	red	SCTLRRF...
	green	SCTLRGF...
	yellow	SCTLRYF...
	blue	SCTLRBF...
stainless steel, polished	white	SVACTLRWF...
	red	SVACTLRRF...
	green	SVACTLRGF...
	yellow	SVACTLRYF...
	blue	SVACTLRBF...

About Us

Control Units

→ Actuators

Panel Mount Jacks

Bus Technology

Enclosures

Terminal Blocks

Pedal Switches

Limit Switches

Type Index

Membrane Pushbuttons

Illustration

Dimensions

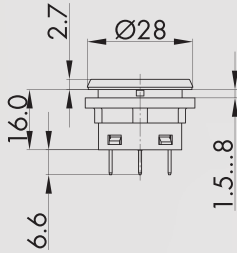

Illuminated Tactile Membrane Pushbutton made of stainless steel V4A

combining the advantages of a membrane keypad with the flexibility of conventional actuators, with blank nameplate.
Standard inscription (see page 404) or special imprints on request

incl. white LED
with gold-plated contacts

Faston terminals 2.8x0.8 mm

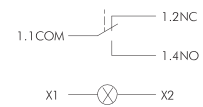

front bezel	1 inverter
stainless steel, polished	SVACFTLF
black	SSWCFTLF

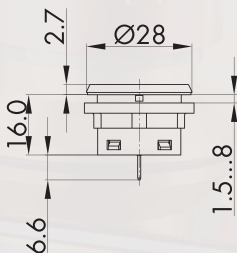

Tactile Membrane Pushbutton made of stainless steel V4A

combining the advantages of a membrane keypad with the flexibility of conventional actuators, with blank nameplate.
Standard inscription (see page 404) or special imprints on request

with gold-plated contacts

Faston terminals 2.8x0.8 mm

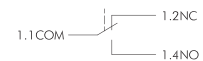

front bezel	1 inverter
stainless steel, polished	SVACFTF
black	SSWCFTF

Capacitive Pushbutton

Illustration

Dimensions

IP66
IP67
IP69K

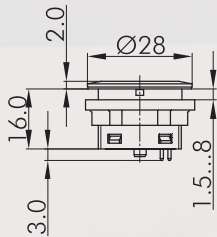

Capacitive Pushbutton

Operation display with four LEDs (Y, permanently lit)
four LEDs light additionally on actuation

Technical Data

Max. Storage temperature: -40°C ... +85°C
Max. Operating temperature: -10°C ... +60°C
Max. Switching frequency (at U_e): 10Hz
Standby delay time: max. 50ms

Electrical Data

Utilisation category: DC13
Operating voltage U_e: nom. 24V DC (12...30VDC)
Max. static voltage drop: 1.5V
Residual ripple: 10% (of U_e)
Rated insulation voltage U_i: 75V DC
Rated operating current I_e: 100mA
No-load current, not actuated: max. 10mA (GB / GN)
Short-circuit protection: yes
Reverse polarity protection: no

Additional Data

Tightening torque (mounting nut): 1.5...1.9Nm
Mounting position: user-defined
Standards: IEC 60947-5-2

⊕ switching

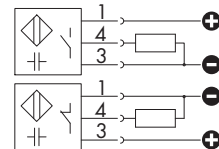

⊖ switching

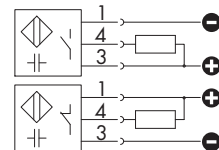

front bezel	illuminated ring	1NO
silver-coloured	yellow/green	SK_GN_GB

Emergency Stops

Type addition for gold-plated version _AU (e.g. FRVKKO_AU)

Illustration

Dimensions

IP66
IP67

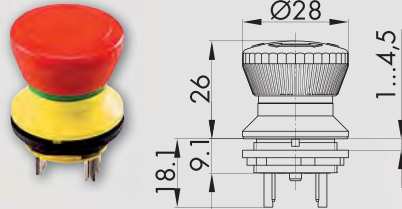

Emergency Stop

Faston terminals 2.8x0.8 mm

foolproof Yes
switching position indicator Yes
anti-lock collar No
release twist right or left
Standard EN 60947-5-1, EN 60947-5, EN ISO 13850

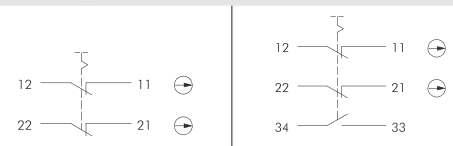

front bezel		2NC	2NC + 1NO
yellow		FRVKKO	FRVKKOI

IP66
IP67

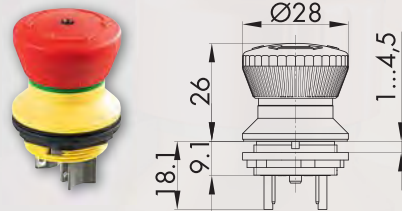

Illuminated Emergency Stop

Faston terminals 2.8x0.8 mm

foolproof Yes
switching position indicator Yes
anti-lock collar No
release twist right or left
Standard EN 60947-5-1, EN 60947-5-5, EN ISO 13850

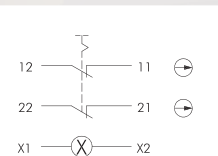

front bezel		2NC	
yellow		FRVKLOO	

IP66
IP67

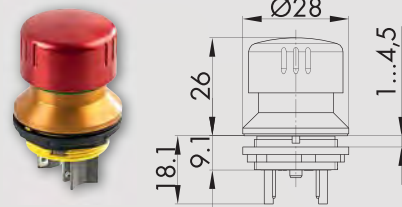

Emergency Stop, made of aluminium for robust applications

Faston terminals 2.8x0.8 mm

foolproof Yes
switching position indicator Yes
anti-lock collar No
release twist right or left
Standard EN 60947-5-1, EN 60947-5-5, EN ISO 13850

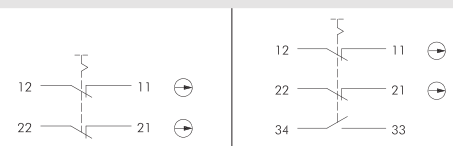

front bezel		2NC	2NC + 1NO
yellow		FRVKALOO	FRVKALOOI

Emergency Stops

Type addition for gold-plated version _AU (e.g. FRVKPOO_AU)

Illustration

Dimensions

IP66
IP69K

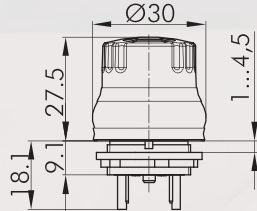

Emergency Stop for hygienic applications

Hygiene-tested acc. to DIN EN 1672-2 / DIN EN ISO 14159 and GS-NV 3, GS-NV 6

Faston terminals 2.8x0.8 mm

foolproof Yes
switching position indicator No
anti-lock collar No
release twist right or left
Standard EN 60947-5-1, EN 60947-5-5, EN ISO 13850

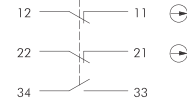
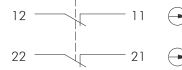
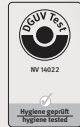

front bezel		2NC	2NC + 1NO
yellow		FRVKPOO	FRVKPOOI

IP66
IP67

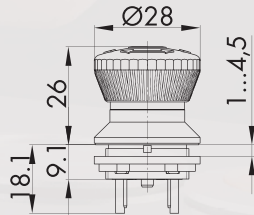

Emergency Stop with pull and twist release

Faston terminals 2.8x0.8 mm

foolproof Yes
switching position indicator Yes
anti-lock collar No
release pull/twist
Standard EN 60947-5-1, EN 60947-5-5, EN ISO 13850

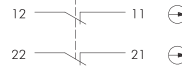

front bezel		2NC
yellow		FRZVKOO

Selector Switches (momentary/maintained)
Type addition for gold-plated version _AU (e.g. SWAOI_AU)

I = Switching position
> = Spring return

Illustration

Dimensions

IP65

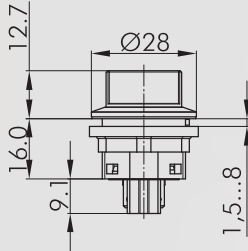

Selector Switch, maintained

Faston terminals 2.8x0.8 mm

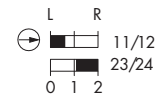
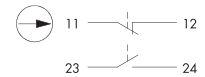
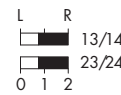
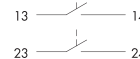
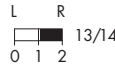
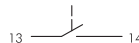

front bezel		1NO	2NO	1NC + 1NO
silver-coloured		SWAI	SWAII	SWAOI
black		SSWWAI	SSWWAII	SSWWAOI
stainless steel, polished		SVAWAI	SVAWAII	SVAWAOI



front bezel

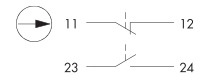
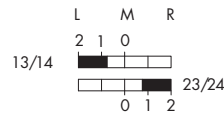
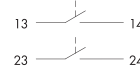

front bezel			2NO	1NC + 1NO
silver-coloured			SWBII	SWBOI
black			SSWWBII	SSWWBOI
stainless steel, polished			SVAWBII	SVAWBOI



Selector Switches (momentary/maintained)

Type addition for gold-plated version _AU (e.g. SWAOI_AU)

I = Switching position

> = Spring return

Illustration

Dimensions

IP65

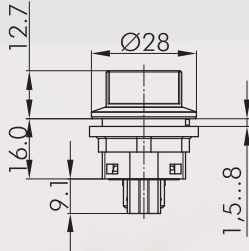

Selector Switch, momentary

Faston terminals 2.8x0.8 mm

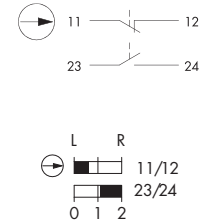
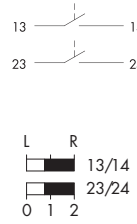
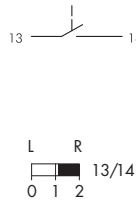

front bezel		1NO	2NO	1NC + 1NO
silver-coloured		SSTAI	SSTAI	SSTAOI
black		SSWSTAI	SSWSTAI	SSWSTAOI
stainless steel, polished		SVASTAI	SVASTAI	SVASTAOI



front bezel

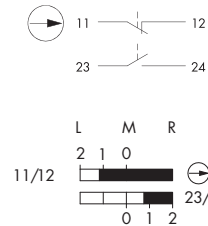
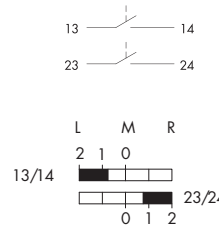

front bezel		2NO	1NC + 1NO
silver-coloured		SSTBII	SSTBOI
black		SSWSTBII	SSWSTBOI
stainless steel, polished		SVASTBII	SVASTBOI



Selector Switches (momentary/maintained)
Type addition for gold-plated version _AU (e.g. SWCOI_AU)

I = Switching position
> = Spring return

Illustration

Dimensions

IP65

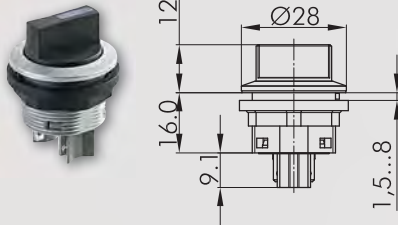

Selector Switch, left maintained, right momentary

Faston terminals 2.8x0.8 mm

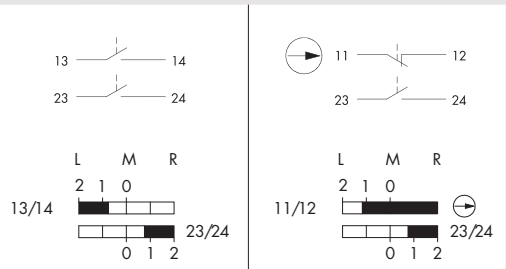

front bezel		2NO	1NC + 1NO
silver-coloured		SWCII	SWCOI
black		SSWWCII	SSWWCOI
stainless steel, polished		SVAWCII	SVAWCOI

IP65

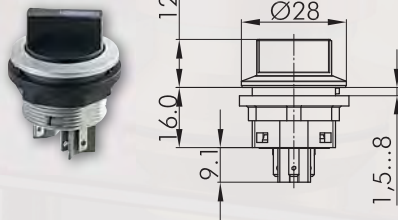

Illuminated Selector Switch, maintained

Faston terminals 2.8x0.8 mm

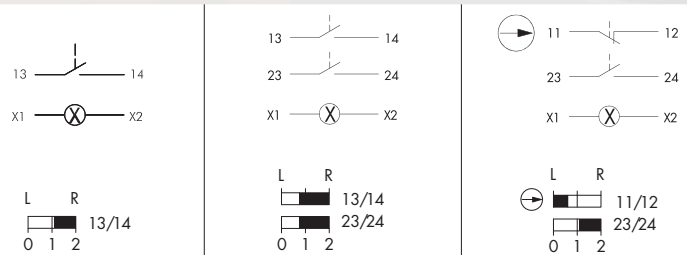

front bezel		1NO	2NO	1NC + 1NO
silver-coloured		SWALI	SWALII	SWALOI
black		SSWWALI	SSWWALII	SSWWALOI
stainless steel, polished		SVAWALI	SVAWALII	SVAWALOI



front bezel		2NO	1NC + 1NO
silver-coloured		SWBLII	SWBLOI
black		SSWWBLII	SSWWBLOI
stainless steel, polished		SVAWBLII	SVAWBLOI

Selector Switches (momentary/maintained)

Type addition for gold-plated version _AU (e. g. SSSA14OIZ_AU)

I = Switching position

> = Spring return

Illustration

Dimensions

IP65

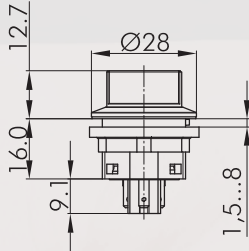

Illuminated Selector Switch, momentary

Faston terminals 2.8x0.8 mm

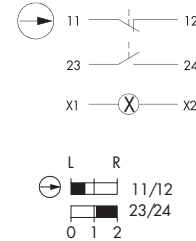
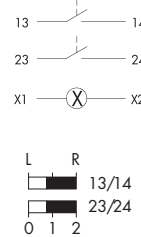
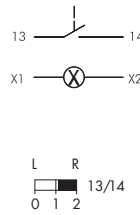

front bezel		1NO	2NO	1NC + 1NO
silver-coloured		SSTALI	SSTALII	SSTALOI
black		SSWSTALI	SSWSTALII	SSWSTALOI
stainless steel, polished		SVASTALI	SVASTALII	SVASTALOI



front bezel		2NO	1NC + 1NO
silver-coloured		SSTBLII	SSTBLOI
black		SSWSTBLII	SSWSTBLOI
stainless steel, polished		SVASTBLII	SVASTBLOI



IP65

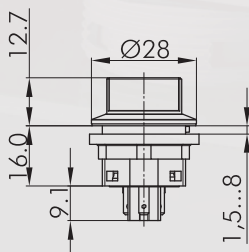

Illuminated Selector Switch, left maintained, right momentary

Faston terminals 2.8x0.8 mm

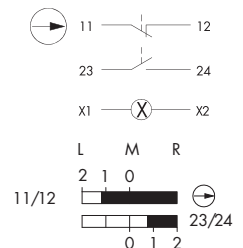
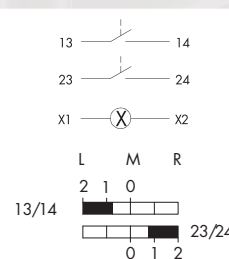

front bezel		2NO	1NC + 1NO
silver-coloured		SWCLII	SWCLOI
black		SSWWCLII	SSWWCLOI
stainless steel, polished		SVAWCLII	SVAWCLOI



Key Switches (momentary/maintained)

Type addition for gold-plated version _AU (e. g. SSSA12OI_AU)

- I = Switching position
- > = Spring return
- = Key removable position

Illustration

Dimensions

IP65

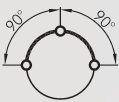
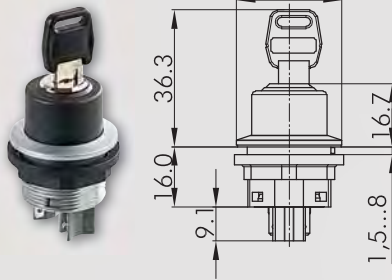

Key-operated Switch, maintained

incl. two keys,
other lock types on request
Faston terminals 2.8x0.8 mm

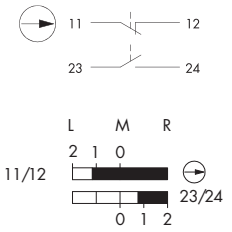
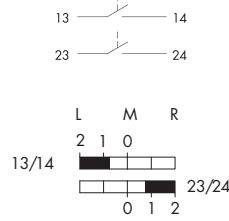

front bezel		2NO	1NC + 1NO
silver-coloured		SSSA12II	SSSA12OI
black		SSWSSA12II	SSWSSA12OI
stainless steel, polished		SVASSA12II	SVASSA12OI

front bezel		2NO	1NC + 1NO
silver-coloured		SSSA13II	SSSA13OI
black		SSWSSA13II	SSWSSA13OI
stainless steel, polished		SVASSA13II	SVASSA13OI

IP65

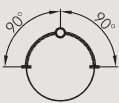
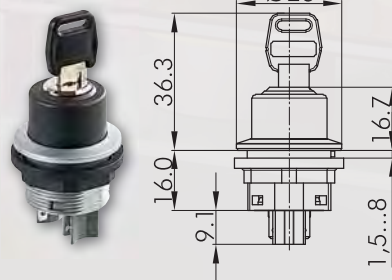

Key-operated Switch, maintained (individually keyed)

incl. three keys
1st key: two-way operation
2nd key: operation only to the left
3rd key: operation only to the right
Faston terminals 2.8x0.8 mm

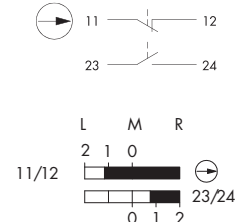
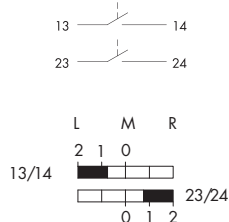

front bezel		2NO	1NC + 1NO
silver-coloured		SSSA31II	SSSA31OI
black		SSWSSA31II	SSWSSA31OI
stainless steel, polished		SVASSA31II	SVASSA31OI

Key Switches (momentary/maintained)

Type addition for gold-plated version _AU (e.g. SSSA14OI_AU)

- I = Switching position
- > = Spring return
- = Key removable position

Illustration

Dimensions

IP65

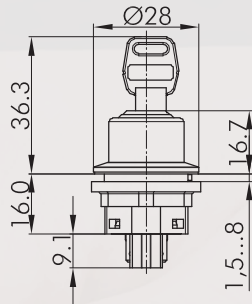

Key-operated Switch, maintained

incl. two keys,
other lock types on request
Faston terminals 2.8x0.8 mm

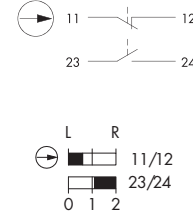
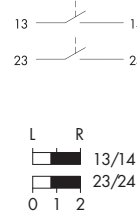
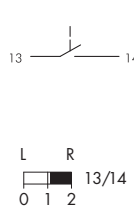

front bezel		1NO	2NO	1NC + 1NO
silver-coloured		SSSA14I	SSSA14II	SSSA14OI
black		SSWSSA14I	SSWSSA14II	SSWSSA14OI
stainless steel, polished		SVASSA14I	SVASSA14II	SVASSA14OI



front bezel		1NO	2NO	1NC + 1NO
silver-coloured		SSSA15I	SSSA15II	SSSA15OI
black		SSWSSA15I	SSWSSA15II	SSWSSA15OI
stainless steel, polished		SVASSA15I	SVASSA15II	SVASSA15OI

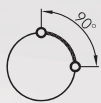

front bezel		1NO	2NO	1NC + 1NO
silver-coloured		SSSA16I	SSSA16II	SSSA16OI
black		SSWSSA16I	SSWSSA16II	SSWSSA16OI
stainless steel, polished		SVASSA16I	SVASSA16II	SVASSA16OI

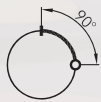

front bezel		1NO	2NO	1NC + 1NO
silver-coloured		SSSA17I	SSSA17II	SSSA17OI
black		SSWSSA17I	SSWSSA17II	SSWSSA17OI
stainless steel, polished		SVASSA17I	SVASSA17II	SVASSA17OI



front bezel		1NO	2NO	1NC + 1NO
silver-coloured		SSSA18I	SSSA18II	SSSA18OI
black		SSWSSA18I	SSWSSA18II	SSWSSA18OI
stainless steel, polished		SVASSA18I	SVASSA18II	SVASSA18OI



About Us

Control Units

Panel Mount Jacks

Bus Technology

Enclosures

Terminal Blocks

Pedal Switches

Limit Switches

Type Index

Actuators

Buzzers

Illustration

Dimensions

IP65

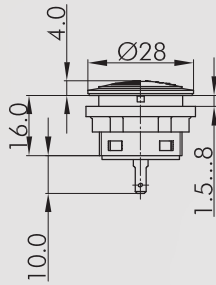

Buzzer

operating voltage: 24V DC
 operating current: 10mA
 signal frequency: 4.1 +/- 0.5 kHz
 volume: max. 83 db (10cm)
 operating temperature: -20°C ... 70°C

Faston terminals 2.8x0.8 mm

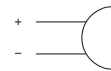

front bezel		1 inverter
silver-coloured		SNSG+SG-24V
black		SSWNSG+SG-24V
stainless steel, polish		SVANSG+SG-24V

Pilot Lights

Lenses and nameplates to be ordered separately.

Illustration

Dimensions

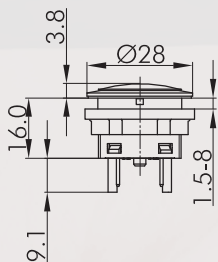

Pilot Light

incl. white LED
Faston terminals 2.8 mm



front bezel		1 inverter
silver-coloured		SNL
black		SSWNL
stainless steel, polished		SVANL



Lens
colour

- blue
- yellow
- green
- clear
- red
- opalwhite

K22RRBL
K22RRGB
K22RRGN
K22RRKL
K22RRRT
K22RRWS



Blank Nameplate

BSRRU



Nameplate with standard imprint

BSRR...

Please specify index number (see nameplates on pages 404)

Nameplate with special imprint

BSRRB

according to customer's specification

Accessories for Control Units

Illustration

Dimensions



Faston Clamp 2.8 x 0.8 mm with snap-in pin

FH2,8

Cross section 0.75 - 1.50 mm², tin-plated brass, with pin to snapfit into the sockets XA, XAL and the insulating case IH2.8



Insulating Case

IH2,8

for Faston clamp FH2,8, slip on from the front

IP40



Lead-sealable Protective Lid

from -30 °C to +70°C

colour

transparent



KDP22RR

IP65
IP67



Lead-sealable, robust Protective Lid

Lifetime: >100,000 cycles

colour

transparent



KDPR22RR

black



KDPR22RR_SW

IP67



Protective Lid made of TPE

from -50 °C to +100°C

colour

black



AK22RRSW



About Us

Control Units
→ Actuators

Panel Mount Jacks

Bus Technology

Enclosures

Terminal Blocks

Pedal Switches

Limit Switches

Type Index